



MP1800 Router Install Manual

V1.2

Maipu Communication Technology Co., Ltd
No. 16, Jiuxing Avenue
Hi-tech Park
Chengdu, Sichuan Province
People's Republic of China - 610041
Tel: (86) 28-85148850, 85148041
Fax: (86) 28-85148948, 85148139
URL: [http:// www.maipu.com](http://www.maipu.com)
Email: overseas@maipu.com

All rights reserved. Printed in the People's Republic of China.

No part of this document may be reproduced, transmitted, transcribed, stored in a retrieval system, or translated into any language or computer language, in any form or by any means, electronic, mechanical, magnetic, optical, chemical, manual or otherwise without the prior written consent of Maipu Communication Technology Co., Ltd.

Maipu makes no representations or warranties with respect to this document contents and specifically disclaims any implied warranties of merchantability or fitness for any specific purpose. Further, Maipu reserves the right to revise this document and to make changes from time to time in its content without being obligated to notify any person of such revisions or changes.

Maipu values and appreciates comments you may have concerning our products or this document. Please address comments to:

Maipu Communication Technology Co., Ltd
No. 16, Jiuxing Avenue
Hi-tech Park
Chengdu, Sichuan Province
People's Republic of China - 610041
Tel: (86) 28-85148850, 85148041
Fax: (86) 28-85148948, 85148139
URL: [http:// www.maipu.com](http://www.maipu.com)
Email: overseas@maipu.com

All other products or services mentioned herein may be registered trademarks, trademarks, or service marks of their respective manufacturers, companies, or organizations.

Contents

Production Introduction.....	6
Product Features	6
Hardware Features	7
MP1800 Series Multi-service Router Appearance	7
Front and Back Panels of MP1800 Series Multi-service Router	7
System Description of MP1800 Series Multi-service Access Router	13
Slots of MP1800 Series Multi-service Access Router	14
Modules.....	16
Sync/Async Serial Interface Module (SAE) Series	16
1-port High-speed V.24/V.35 Serial Module (1SAE)	16
Channelized E1 Module (CE1)	17
1-port Channelized E1 Module (1CE1)	17
Non-channelized E1 (E1) Series	18
1-port Non-channelized E1 Module (1E1)	18
IP Phone Module (VOP/VOS) Series	19
IP Phone Module of 1-port IP Phone (1VOP)	19
IP Phone Module of 2-port Phone (2VOP)	20
IP Phone Module of 1-port Switch (1VOS)	21
IP Phone Module of 2-port Switch (2VOS)	22
ISDN S/T Module (STA) Series	23
1-port ISDN S/T Module (1STA)	23
Asyn Serial Module (A) Series	24
8-asyn Serial Module (8AX)	24
ADSL Module	25
G.SHDSL Series Module	26
2-port G.SHDSL	26
4-port G.SHDSL	26
Interface Attributes of G.SHDSL Interface Module	27
4S10 Module	27
3G Series Module	28
RM2-3G-CDMA	29
RM2-3G-GSM	29
RM2-3G-TD	30

Install USIM Card	31
SM1 Module	31
RM2-SM1 Module Appearance.....	31
Installation Preparations	32
Security Suggestions	32
Environment Requirements	32
Temperature and Humidity	33
Dust-free Environment	34
Anti-static	34
Electromagnetic Environment Requirements.....	35
Anti-lightning	35
Check Routers & Accessories	36
Tools & Equipment.....	36
System Installation	37
Preparations.....	37
Tools	37
Cabinet Installation.....	37
Install Device on Desk.....	41
Install Device on Wall.....	41
Connect Host Cables	42
Connect Protection Ground Wire	43
Connect Power Supply	43
Module Installation.....	45
Connect 1SAE Interface Cable.....	45
Connect 1CE1/1E1 Module Interface Cable.....	47
Connect 1VOP/2VOP Module Interface Cable	48
Connect 1VOS/2VOS Module Interface Cable.....	48
Connect 1ST Module Interface Cable	49
Connect 8AX Module Interface Cable	49
Connect ADSL Module Interface Cable.....	49
Connect G.SHDSL Module Interface Cable	50
Connect 4S1O Module Interface Cable.....	50
Cables	51
Ethernet Interface Cable.....	51
Ethernet Optical Interface Cable.....	52
Console Port Cable.....	52
4S1O Interface Distribution Box	53
4S1O Interface Cable.....	53
G.SHDSL Interface Cable.....	54

Production Introduction

MP1800 is one new multi-service router developed by Maipu, integrating the routing technology, switching technology, security technology, 3G, WLAN, traffic control, and network-surf monitoring. It is the MeIN (Multi-service Edge-Intelligent Network) edge network device with high cost-effective and complete functions. It adopts the fixed configuration and modular design. The fixed configuration meets the cable and fiber broadband access. The modules are expanded to provide 3G, xDSL, PON, V24/V35, E1/CE1, and ISDN broadband and narrowband access capabilities, as well as the load balance mechanism of various access combinations.

Product Features

- Wired and wireless integration, supporting 3G and WLAN access and inter-connecting with the wired network seamlessly
- Routing and switching integration, supporting two Ethernet WAN ports + 4/8 Ethernet LAN ports
- Broadband and narrowband integration, supporting N*64K-100M WAN link interface and directly supporting optical interface uplink
- WAN and LAN integration; the software function completely supports controlling and managing WAN and LAN in a centralized manner
- Data and voice integration, supporting data multi-service development and VoIP function and can be expanded as IPPBX further
- Information and communication integration, supporting rich value-added application and network application monitoring

Hardware Features

MP1800 Series Multi-service Router Appearance



MP1800 multi-service access router

Front and Back Panels of MP1800 Series Multi-service Router



Front and back panels of RM1800-21-AC router



Front and back panels of RM1800-22-AC router



Front and back panels of RM1800-23-AC router



Front and back panels of RM1800-31-AC router

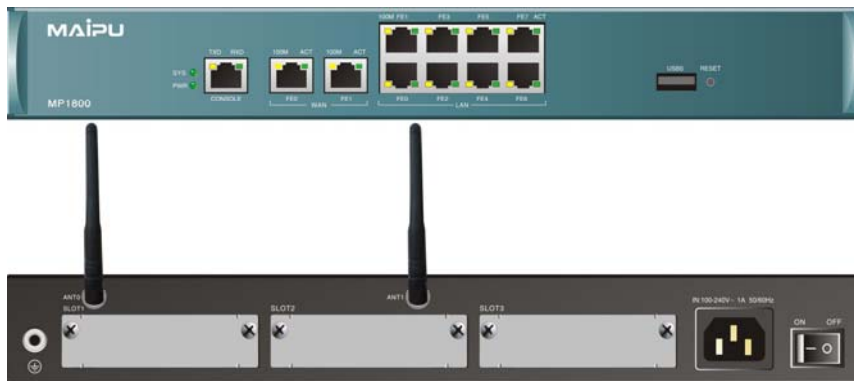

Front and back panels of RM1800-31W-AC router



Front and back panels of RM1800-31W-DC48 router



Front and back panels of RM1800-35-AC router

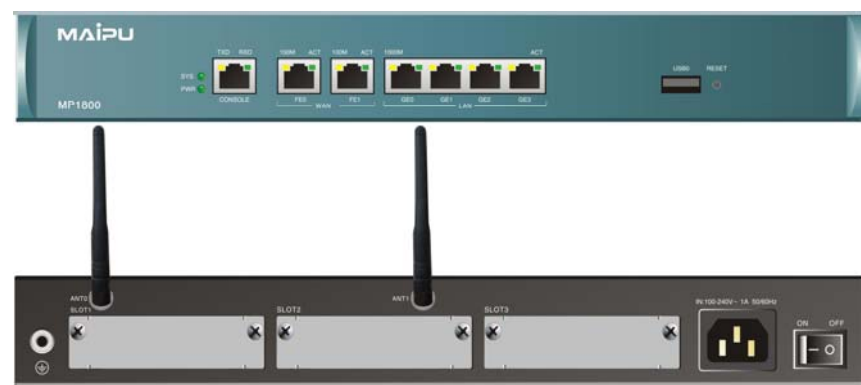

Front and back panels of RM1800-35W-AC router



Front and back panels of RM1800-36W-AC router



Front and back panels of RM1800-36-AC router

The meanings of the indicators on the front and back panels of the above routers:

SYS & PWR (system and power)

- SYS: system status indicator; after the system loads successfully, the indicator flashes slowly;
- PWR: system power indicator; when the 5V power works normally, the indicator becomes on;

CONSOLE (console port)

- TXD: data sending indicator of the console port
- RXD: data receiving indicator of the console port

FE0 (WAN Ethernet 0)

- 100M: data rate indicator of 10/100M Ethernet port; on for 100M and off for 10M;
- LINK/ACT: Ethernet port connection/data receiving and sending indicator

FE1 (WAN Ethernet 1)

- 100M: data rate indicator of 10/100M Ethernet port; on for 100M and off for 10M;
- LINK/ACT: Ethernet port connection/data receiving and sending indicator

LAN Ethernet port 0-7

RM1800-21-AC, RM1800-22-AC, RM1800-23-AC, RM1800-31-AC, RM1800-31W-AC, RM1800-31W-DC48:

- Yellow light (left): data rate indicator of 10/100M Ethernet port; on for 100M and off for 10M;
- Green light (right): data receiving and sending indicator of Ethernet port

RM1800-35-AC, RM1800-35W-AC, RM1800-36-AC, RM1800-36W-AC:

- Yellow light (left): data rate indicator of 100/1000M Ethernet port; on for 1000M and off for 100M;
- Green light (right): data receiving and sending indicator of Ethernet port

The description of the interfaces:

The interfaces on the front panel of MP1800 series router

Device Type	Interface	Interface Type	Description
RM1800-21-AC	CONSOLE	RJ45	Console port
	WAN port	RJ45	One 100M Ethernet electric port
	LAN port	RJ45	Four 100M Ethernet electric ports
RM1800-22-AC	CONSOLE	RJ45	Console port
	WAN port	RJ45	Two 100M Ethernet electric ports
	LAN port	RJ45	Four 100M Ethernet electric ports
	USB port	USB interface	One USB interface
RM1800-23-AC	CONSOLE	RJ45	Console port
	WAN port	RJ45	Two 100M Ethernet electric ports
	USB port	USB interface	One USB interface
RM1800-31-AC RM1800-31W-AC RM1800-31W-DC48	CONSOLE	RJ45	Console port
	WAN port	RJ45	Two 100M Ethernet electric ports
	LAN port	RJ45	Eight 100M Ethernet ports
	USB port	USB interface	One USB interface

RM1800-35-AC RM1800-35W-AC	CONSOLE	RJ45	Console port
	WAN port	RJ45	Two 100M Ethernet electric ports
	LAN port	RJ45	Four 1000M Ethernet electric ports
	USB port	USB interface	One USB interface
RM1800-36-AC RM1800-36W-AC	CONSOLE	RJ45	Console port
	WAN port	SFP	Two 100M Ethernet electric ports
	LAN port	RJ45	Four 1000M Ethernet electric ports
	USB port	USB interface	One USB interface

The interfaces on the back panel of the MP1800 series router

Interface	Interface Type	Description	Corresponding slot
ON/OFF		The power switch, ON or OFF	
IN		AC: 100-240V Max. Current: 1A	
		DC: -57- -40V Max. current: 2A	
SLOT3	The interface type depends on the interface module.	Bus slot	Multi-function module
SLOT2	The interface type depends on the interface module.	Bus slot	Multi-function module
SLOT1	The interface type depends on the interface module.	Bus slot	Multi-function module

System Description of MP1800 Series Multi-service Access Router

The basic configuration and working environment of MP1800 router are as follows:

MP1800 router system

Item	Description	
Console port	One (RJ45), asyn DTE working mode	
Ethernet port	Two 10/100M fast Ethernet ports (RJ45), except for RM1800-21-AC One 10/100M fast Ethernet port (RJ45), RM1800-21-AC	
High-speed multi-function slot	Three high-speed multi-function slots	
USB high-speed interface	One (except for RM1800-21-AC)	
Processor	High-speed RISC processor	
FLASH	32Mbyte	
SDRAM	256Mbyte	
Domension (W×D×H)	RM1800-21-AC RM1800-22-AC RM1800-23-AC RM1800-35-AC RM1800-35W-AC RM1800-36-AC RM1800-36W-AC	340 x 260 x 43.8
	RM1800-31-AC RM1800-31W-AC RM1800-31W-DC48	340 x 300 x 43.8
Max. weight	<4.5 Kg	
Input voltage	AC 100-240V, 50/60Hz	
	DC -57- -40V	
Environment temperature	Working temperature for a long term: 5~40℃ Working temperature for a short term (48 hours): -5~45℃	
Environment humidity	10-90% no-condensing	

Rated power	50W
Max. power	36W±10% (RM1800-31-AC, RM1800-31W-AC, RM1800-31W-DC48); 30W±10% (RM1800-21-AC, RM1800-22-AC, RM1800-23-AC, RM1800-35-AC, RM1800-35W-AC); 26W±10% (RM1800-36-AC, RM1800-36W-AC)

Slots of MP1800 Series Multi-service Access Router

Slots of MP1800 series router

Device Type	Description
RM1800-21-AC	RM2-1STA, 8AX, 1/2VoS, 1/2VoP, 4S1O, and SM1 modules are suitable for slot 1, slot 2, and slot 3. RM2-1SAE module is suitable for slot 1 and slot 2. RM2-1E1 and 1CE1 modules are suitable for slot 1. RM2-1ADSL and xGSHDSL modules are suitable for slot 2.
RM1800-22-AC RM1800-23-AC	RM2-1STA, 8AX, 1/2VoS, 1/2VoP, 4S1O, and SM1 modules are suitable for slot 1, slot 2, and slot 3. RM2-1SAE module is suitable for slot 1 and slot 2. RM2-1E1 and 1CE1 modules are suitable for slot 1. RM2-1ADSL and xGSHDSL modules are suitable for slot 2., but when the modules are inserted, WAN1 (FE1) on the front panel is unavailable. The 3G module of RM2 is suitable for slot 3.
RM1800-35W-AC RM1800-35-AC RM1800-31-AC RM1800-31W-AC RM1800-31W-DC48	RM2-1STA, 8AX, 1/2VoS, 1/2VoP, 4S1O, and SM1 modules are suitable for slot 1, slot 2, and slot 3. RM2-1SAE module is suitable for slot 1 and slot 2. RM2-1E1 and 1CE1 modules are suitable for slot 1. RM2-1ADSL and xGSHDSL modules are suitable for slot 2., but when the modules are inserted, WAN1 (FE1) on the front panel is unavailable. The 3G module of RM2 is suitable for slot 3.
RM1800-36W-AC RM1800-36-AC	RM2-1STA, 8AX, 1/2VoS, 1/2VoP, 4S1O, and SM1 modules are suitable for slot 1, slot 2, and slot 3. RM2-1SAE module is suitable for slot 1 and slot 2. RM2-1E1 and 1CE1 modules are suitable for slot 1. The 3G module of RM2 is suitable for slot 3.

 Note

RM1800-31W-AC, RM1800-31W-DC48, RM1800-35W-AC, and RM1800-36W-AC support wireless WLAN function. WLAN uses 2.4G frequency band, so the other devices that use 2.4G frequency band will cause interference for WLAN. In serious case, WLAN cannot be used. The 2.4G frequency-band devices include Bluetooth device, microwave oven, digital wireless cordless phone and so on. Therefore, when using WLAN, we should avoid the interference of the wireless signals.

Modules

MP1800 router is a modular router. It provides three slots. Currently, the available modules include 1SAE, 1CE1, 1E1, 1STA, 8AX, 1VOP, 2VOP, 1VOS, 2VOS, 4S10, 1ADSL, 2SHDSL, 4SHDSL, 3G-CDMA, 3G-GSM, 3G-TD, and SM1. This chapter describes several common modules.

Sync/Async Serial Interface Module (SAE) Series

1-port High-speed V.24/V.35 Serial Module (1SAE)

1SAE module is used for MP1800 router. 1SAE completes 1-port sync/async serial data flow – receiving/sending and processing. The port operates in synchronous mode:

DCE mode: 2.048Mbps

DTE mode: 8 Mbps

The port in asynchronous mode operates 115.2Kbps. The default working mode of MP1800 router sync/async serial interface is sync. The sync serial interface is in DTE or DCE mode. In DTE mode, it receives external DCE clock such as external sync modem. In DCE mode, the router provides clock. The V24/V35 mode switch functions via the buttons on the panel.

1SAE Interface Module

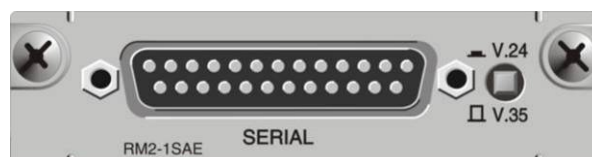

1-port high-speed V.24/V.35 serial module (1SAE)

Cables of 1SAE Interface Module

1SAE interface cable is V35 common DTE cable and V24 straight-through DTE cable.

1SAE Interface Attributes

1-port high-speed V.24/V.35 serial module (1SAE) attributes:

Attributes	Description		
	Sync		Async
Tie-in	DB25-DB25		DB25-DB25
Interface standard & working mode	V.24	V.35	EIA/TIA-232
	DTE DCE	DTE DCE	
Minimum baud rate (bps)	1200	1200	300
Maximum baud rate (bps)	128K	8M	115.2K
Supported protocol & service	X25 HDLC PPP SLIP FR LAPB		Dialup Backup
			HDLC PPP SLIP

Channelized E1 Module (CE1)

1-port Channelized E1 Module (1CE1)

The 1-port channelized E1 module provides the ports for receiving, sending and processing 1984K multi-timeslot data flow. As CE1 interface, it divides slot 1-31 to different groups and each group of timeslots serves as one interface after binding.

1CE1 Interface Module Appearance & Indicators



1-port channelized E1 module (1CE1)

The meanings of the indicators:

LOS	On: Cannot check frame sync signal Off: After sync
-----	---

Cables of 1CE1 Interface Module

1CE1 matches BNC pin coaxial cable and RJ45-RJ45 straight-through twisted-pair.

1CE1 Interface Attributes

1-port Channelized E1 (1CE1) interface attributes:

Attributes	Description
Interface	BNC, RJ45 (can not be used together)
Interface number	1 group
Interface standard	G.703
Supported protocol	PPP X.25 HDLC FR

Non-channelized E1 (E1) Series

1-port Non-channelized E1 Module (1E1)

The 1-port non-channelized E1 module provides a data transmission port with 2.048Mbit/s bandwidth. E1 is the same as CE1. It can be divided into 32 timeslots, and timeslot 0 of E1 can be used to transmit data in unframed mode to realize 2M transparent transmissions.

1E1 Interface Module Appearance and Indicators

The appearance of the 1E1 interface module:



1-port non-channelized E1 module (1E1)

The meanings of the indicators:

LOS	On: Transparent 2M transmission On: Non-transparent and cannot check frame sync signal Off: After sync
-----	---

Cables of 1E1 Interface Module

1E1 matches BNC pin coaxial cable and RJ45-RJ45 straight-through twisted-pair.

1E1 Interface Attributes

1-port non-channelized E1 (1E1) interface attributes:

Attributes	Description
Interface	BNC, RJ45 (cannot be used together)
Interface number	1 group
Interface standard	G.703
Supported service	X.25 FR
Supported protocol	PPP HDLC

IP Phone Module (VOP/VOS) Series

IP Phone Module of 1-port IP Phone (1VOP)

1-port IP phone module accesses any telephone via IP network. The user can make free phone calls via the constructed IP network.

1VOP Interface Module Appearance & Indicators

The appearance of 1VOP interface module:

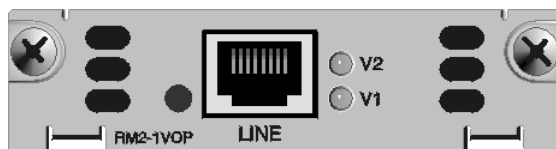

1-port IP phone module (1VOP)

The meanings of the indicators:

V1	IP phone module indicator, and the light is on during the call
V2	Maybe the 1VOP module does not have the indicator, and if yes, the indicator is not on forever.

Cables of 1VOP Interface Module

The cables of the 1VOP module are RJ45 (4, 5 signal cable) and RJ11 phone wire.

1VOP Interface Attributes

1-port IP phone module (1VOP) interface attributes:

Attributes	Description
Interface	RJ45 jack
Interface number	1
Supported protocol	H.225 H.245 RTP RTCP G.711 G.723 G.729

IP Phone Module of 2-port Phone (2VOP)

The 2-port IP phone module accesses any call in IP network via dialup. The user can make free phone calls via the constructed IP network.

2VOP Interface Module Appearance & Indicators

The appearance of the 2VOP interface module:

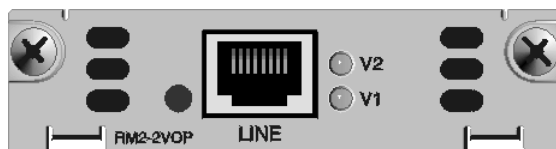

The meanings of the indicators:

V1	IP phone module indicator It is on during the call after pickup.
V2	IP phone module indicator It is on during the call after pickup.

Cables of 2VOP Interface Module

The cable of the 2VOP module is RJ45 external cable.

2VOP Interface Attributes

2-port IP phone module (2VOP) interface attributes

Attributes	Description
Interface	RJ45 jack (two RJ11 plugs)
Interface quantity	2 (RJ11)
Supported protocols	<ul style="list-style-type: none"> ·H.225 ·H.245 ·RTP ·G.711 ·G.723 ·G.729

IP Phone Module of 1-port Switch (1VOS)

The IP phone module of the 1-port switch accesses any phone in IP network via dialup or secondary dialup. The user can make free phone call via the constructed IP network.

1VOS Interface Module Appearance & Indicators

The appearance of the 1VOS interface module:

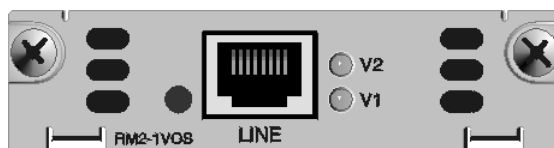

The meanings of the indicators:

V1	IP phone module indicator, and the indicator is on during the call
V2	Maybe the 1VOS module does not have the indicator, and if yes, the indicator is not on forever.

Cables of 1VOS Interface Module

The cables of the 1VOS module are RJ45 (4, 5 signal cable) and RJ11 phone wire.

1VOS Interface Attributes

The 1-port switch IP phone module (1VOS) interface attributes:

Attribute	Description
Interface	RJ45 jack
Interface quantity	1
Supported protocols	<ul style="list-style-type: none"> ·H.225 ·H.245 ·RTP ·G.711 ·G.723 ·G.729

IP Phone Module of 2-port Switch (2VOS)

The IP phone module of the 2-port switch accesses any phone in IP network via dialup or secondary dialup. The user can make free phone call via the constructed IP network.

2VOS Interface Module Appearance & Indicators

The appearance of the 2VOS interface module:

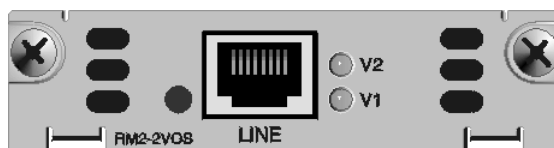

The meanings of the indicators:

V1	IP phone module indicator It is on during the call.
V2	IP phone module indicator It is on during the call.

Cables of 2VOS Interface Module

The cable of the 2VOS module is the RJ45 external line.

2VOS Module Interface Attributes

2-port switch IP phone module (2VOS) interface attributes

Attributes	Description
Interface	RJ45 jack (two RJ11 plugs)
Interface quantity	2 (RJ11)
Supported protocols	<ul style="list-style-type: none"> ·H.225 ·H.245 ·RTP ·G.711 ·G.723 ·G.729

ISDN S/T Module (STA) Series

1-port ISDN S/T Module (1STA)

1-port ISDN S/T (1STA) module can realize the 64K or 128K high-speed access and backup. It is the hardware upgrade version of the 1-port ISDN S/T (1ST) with the better slot compatibility and is compatible with the former software/hardware functions.

1STA Interface Module Appearance & Indicators

The appearance of 1STA interface module:

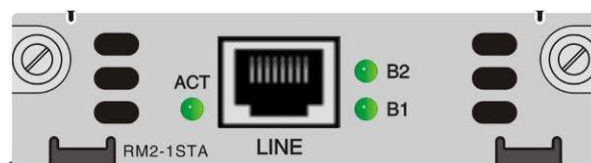

The meanings of the indicators:

ACT	Activated indicator; it is on when running normally.
B1	B1 channel indicator; it is on when using the channel B1, that is, rate is B1=64K or B1+B2=128K.
B2	B2 channel indicator; it is on when using the channel B2, that is, rate is B2=64K or B1+B2=128K.

Cables of 1STA Interface Module

The 1STA cable is the RJ45 direct-connected cable.

1STA Module Interface Attributes

The interface attributes of the 1STA module:

Attribute	Description
Tie-in	RJ45
Tie-in quantity	1
Supported protocol	PPP

Asyn Serial Module (A) Series

8-asyn Serial Module (8AX)

8-asyn serial module is to receive and send the data flow of the 8-port asyn interface. The maximum rate of each port can reach 115.2K only when running in the asyn mode.

8AX Interface Module Appearance

The appearance of the 8AX interface module:

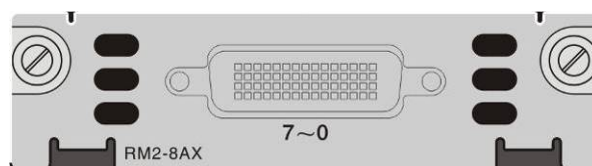

Cables of 8AX Interface Module

The cable of the 8AX module is 8-asyn serial cable.

Interface Attributes of 8AX Interface Module

The interface attributes of the 8AX module:

Attribute	Description
Tie-in	DB60
Interface standard	RS-232
Min. baud rate (bps)	300
Max. baud rate (bps)	115.2K
Supported services	Connecting terminals (with the terminal number fixing function); Connecting ATM; Connecting PC workstation; Connecting router; Connecting frequency-band or base-band modem; PC or router dialup access; Other serial devices;
Supported protocols	·X.25 ·HDLC ·PPP ·SLIP

ADSL Module

RM2-1ADSL module is used by MP1800 series multi-service access router, connecting to Internet via one RJ11 interface.

The appearance of the ADSL interface module:

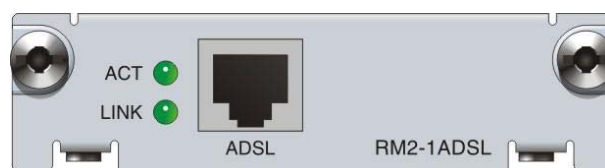

RM2-1ADSL panel

The physical ports on the RM2-1ADSL module panel is RJ11, connecting the telephone twisted-pair to access Internet. The module panel has two indicators, that is, Link and ACT. When the Link indicator is off, it means that the interface is not connected; when Link is on, it indicates that the interface is connected. When ACT is off, it indicates that the interface does not have data sent or sent; when ACT flashes, it indicates that the interface has data sent and received.

G.SHDSL Series Module

2-port G.SHDSL

RM2-2SHDSL module is used by MP1800 series multi-service access router, realizing 2-port access Internet via one RJ45 interface.

The appearance of the G.SHDSL interface module:

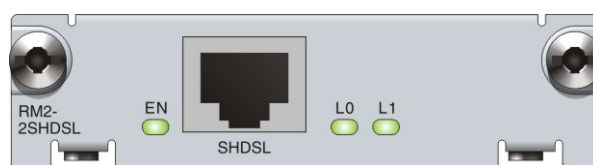

G.SHDSL panel

The physical port on the RM2-2SHDSL module panel is RJ45, connecting 2-port telephone twisted-pair to access Internet. There are three indicators on the module panel, that is, EN indicator and two status indicators, indicating the status of the card.

4-port G.SHDSL

RM2-4SHDSL module is used by MP1800 series multi-service access router, realizing 4-port access Internet via one RJ45 interface.

The appearance of the G.SHDSL interface module:

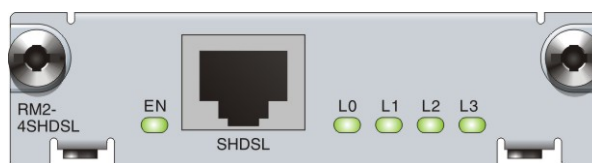

G.SHDSL panel

The physical port on the RM2-2SHDSL module panel is RJ45, connecting 4-port telephone twisted-pair to access Internet. There are five indicators on the module panel, that is, EN indicator and four status indicators, indicating the status of the card.

Interface Attributes of G.SHDSL Interface Module

The interface attributes of the G.SHDSL module:

Attribute	Description
Interface	RJ45 jack
Interface quantity	2 or 4
Supported protocols	<ul style="list-style-type: none"> ·ITU G.hs (ITU-T G.994.1) ·ITU G.shdsl (ITU-T G.991.2) ·ITU G.shdls.bis (ITU-T G.991.2 (2004))

4S1O Module

RM2-4S1O module is used for the phone analog access and local external access. The physical ports on the RM2-4S1O module panel include four RJ11. Port 0 is the shared port of FXO and FXS0, and the other three ports are FXS analog access port 1-3.

4S1O Interface Module Appearance

The appearance of the 4S1O interface module:

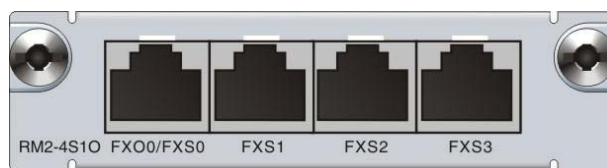

RM2-4S10 panel

Cables of 4S10 Interface Module

The cable of the 4S10 module is RJ11 cable.

Note: If port 0 is connected to FXO port, the distribution box is needed (the distribution box is distributed with the 4S10 card), which is 1 input and 2 output. The input is mixed port; the output are one FXO port and one FXS port.

4S10 Module Interface Attributes

The interface attributes of the 4S10 module:

Attribute	Description
Interface	RJ45 jack
Interface quantity	5
Supported protocols	<ul style="list-style-type: none"> ·H.225 ·H.245 ·RTP ·G.711 ·G.723 ·G.729

3G Series Module

RM2-3G module realizes the 3G Internet function. The module is suitable for SLOT3. It includes RM2-3G-CDMA, RM2-3G-GSM, and RM2-3G-TD.

ANT0 and ANT1 on the front panel are the wireless input ports of the 3G module.

RM2-3G-CDMA

RM2-3G-CDMA module needs to insert the CDMA2000 3G module and USIM card.

The appearance of the RM2-3G-CDMA module:



RM2-3G-CDMA panel

The meanings of the indicators on RM2-3G-CDMA module

WWAN	Green	Off: power-off
		On: power-on
RSSI	Green	Off: weak signal $\leq -116\text{dBm}$
		On: Strong signal $\geq -78\text{dBm}$
		Flash: $-78\text{dBm} > \text{middle/low signal} > -116\text{dBm}$
1xRTT	Green	Off: no 1xRTT service
		On: with 1xRTT service
EVDO	Green	Off: no EVDO service
		On: with EVDO service

RM2-3G-GSM

RM2-3G-GSM module needs to insert the WCDMA 3G module and USIM card.

The appearance of the RM2-3G-GSM module:



RM2-3G-GSM panel

The meanings of the indicators on RM2-3G-GSM module:

WWAN	Green	Off: power-off
		On: with services, but not enter the data mode
		Flash slowly: Searching the service (4.75s off, 0.25s on);
		Flash quickly: with services and enter the data mode (the flash frequency depends on the received data traffic. The larger the

		data traffic, the more quickly the indicator flashes. When there is no traffic, the flash interval is 4s)
RSSI	Green	Off: weak signal $\leq -103\text{dBm}$
		On: Strong signal $\geq -55\text{dBm}$
		Flash: $-55\text{dBm} > \text{middle/low signal} > -103\text{dBm}$
UMTS	Green	Off: no GSM/GPRS service
		On: with GSM/GPRS service
HSDPA	Green	Off: no HSDPA service
		On: with HSDPA service

RM2-3G-TD

RM2-3G-TD module needs to insert the TD-SCDMA 3G module and USIM card.

The appearance of the RM2-3G-TD interface module:



RM2-3G-TD panel

The meanings of the indicators on RM2-3G-TD module:

WWAN	Green		Off: power-off
			On: power-on
RSSI	Green	GSM/GPRS service	Off: weak signal $\leq -103\text{dBm}$
			On: Strong signal $\geq -55\text{dBm}$
			Flash: $-55\text{dBm} > \text{middle/low signal} > -103\text{dBm}$
		TDSCDMA service	Off: weak signal $\leq -106\text{dBm}$
			On: Strong signal $\geq -34\text{dBm}$
			Flash: $-34\text{dBm} > \text{middle/low signal} > -106\text{dBm}$
UMTS	Green		Off: no GSM/GPRS service
			On: with GSM/GPRS service
HSDPA	Green		Off: no TD-SCDMA service
			On: with TD-SCDMA service

Install USIM Card

USIM card is used to store the accounting information. The USIM card is purchased by the user. The metal face of the USIM card is adown. Refer to the appearance diagram of the cassette, Plug and Play.

SM1 Module

The RM2-SM1 module is used to encrypt and de-encrypt. The panel of the RM2-SM1 module does not have external interface.

RM2-SM1 Module Appearance

The appearance of the RM2-SM1 interface module is as follows:

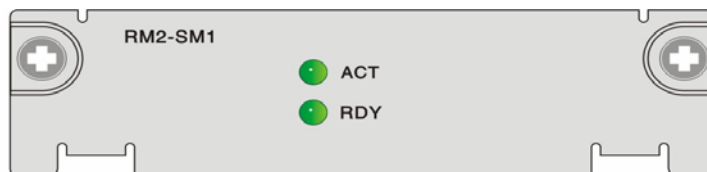

RM2-SM1 panel diagram

The indicators of the RM2-SM1 module:

ACT	On: Some data is encrypted or de-encrypted; Off: Idle
RDY	On: The card is available, that is, RDY and ENABLE are valid at the same time; Off: The card is unavailable; Flash: The card is RDY, but the host does not enable.

Installation Preparations

Security Suggestions

To avoid the harms on persons and equipments caused by various accidents, comply with the following:

- Keep the router far away from humid places and heat
- Ensure that router is well grounded
- Wear anti-static wrists during installation and maintenance
- Do not install, move and dismantle routers and modules during power on to avoid damages on persons and equipments
- Do not hot swap interface modules and interface cards of routers
- Connect the interface cables of routers correctly, especially do not connect phone lines (including ISDN lines) to serial ports
- Pay attention to the laser use security (for example, do not keep eyes open at the optical emitting mouth of LASER or the fiber connecter)
- Use Uninterrupted Power Supply (UPS)
- Router AC power supply is soft start control switch, which does not cut the main return circuit of AC power supply. During installation, the external control switch of main return circuit needs to be connected so as to cut down power supply fast in case of accidents.

Environment Requirements

MP1800 series routers must be used indoor. To guarantee stable use of routers and prolong the life, the application scenario must meet the following requirements.

Temperature and Humidity

To ensure the service quality and life of MP1800 series routers, it is recommended to maintain a certain temperature and humidity in the computer lab. If the humidity in the computer lab is high for long time, it causes the poor insulation and even electricity leak of insulation materials easily.

Sometimes, the mechanical performances of materials change and the metal parts are corroded easily, too. If the relative humidity is too low, insulation pads shrink, which causes the fastened screws loose. Meanwhile, in dry environment, static electricity appears easily, which harms the circuits on the router.

If the temperature is too high, the reliability of the router reduces greatly. The long-time high temperature affects the life and speeds up the aging of insulation materials.

The recommended temperature and humidity in computer room:

Temperature		Relevant humidity	
Long-term	Short-term	Long-term	Short-term
0~40℃	0~50℃	40%~65%	10%~90%

Note

- Measuring points of the working temperature and humidity of MP1800 in the computer room mean the values measured from the floor above 1.5 m and 0.4 m from the front of the rack when there are no protection boards.
- The short-term working condition means less than 48h continuously and less than 15 days for the annual total.
- Extreme adverse working environment means the environment temperature and humidity when the air-conditioning system in the computer room fails. Each time the normal work should be recovered within less than 5h.

Dust-free Environment

Dust is harmful for MP1800 operation. Dust causes static absorption, which makes the poor contact of metal pieces. Static absorption appears especially when the temperature and humidity are lower, which affects the device life and causes communication fault.

Dust requirements for the room:

Maximum diameter (μm)	0.5	1	3	5
Maximum concentration (contained particles per m^3)	1.4×10^7	7×10^5	2.4×10^5	1.3×10^5

Apart from dust, the router has strict requirements for SO_2 , H_2S , NH_3 , and Cl_2 in the room, because these harmful gases speed up the eroding of metals and the aging of some components.

The specific limitations are as follows:

Gas	Maximum value (mg/m ³)
SO_2	0.2
H_2S	0.006
NH_3	0.05
Cl_2	0.01

Anti-static

MP1800 router takes lots of measures in anti-static, but when the static exceeds a certain volume, the circuits even the whole monitor are damaged.

For router communication, static electricity originates from external electric field of high-pressure like electricity cables and thunders, and internal system such as floor material and chassis structure. To prevent the damage caused by the static, do as follows:

- Ensure proper equipment grounding
- Maintain dustproof room
- Keep suitable temperature & humidity
- Wear anti-static equipment
- Place the disassembled circuit board on the anti static workstation and keep the face upturned or in the anti static bag

- When viewing or removing the disassembled circuit board, touch the edge of circuit board and avoid touching the components on the circuit board.

Electromagnetic Environment Requirements

The various interference sources no matter from the exterior of devices or application systems or from the interior affect the devices through capacitance coupling, inductance coupling, electromagnetic radiation, public impedance (including grounding system) and lead (such as power lines, signal lines and output lines).

Therefore, pay attention to the following:

- Take anti-electric network interference for power system.
- The router working place had better not be used with the grounding settings of power devices or anti-thunder grounding settings and the distance between them had better be as long as possible.
- Be away from the strong power radio transmitters, radar transmitter, and high frequency high-current equipments.
- Take electromagnetic shielding methods when necessary.

Anti-lightning

MP1800 router takes lots of measures in anti-lightning, but when the lightning exceeds a certain volume, the router may be damaged. To prevent the damages caused by lightning, do as follows:

- Ensure that the protect ground of the chassis is well grounded;
- Ensure that the grounding point of AC power supply jack is well grounded;
- Add power lightning arrester to the input end of the power supply, so as to improve the anti-lightning capability of the power supply;
- To improve the anti lightning capability, the MP7500 interface modules are connected to outdoor signal lines. You can add special anti-lightning equipment to the input end of signal lines.

Check Routers & Accessories

After ensuring the installation environment requirements are met, you can open the package. However, before installation, check whether the router and the accessories are complete according to the purchase order.

Tools & Equipment

Tools

- Slotted point screwdriver/cross point screwdriver
- Level, ruler or tapeline
- Anti-static equipment

Connected cables

- Cables in the package

Equipment

- HUB or Ethernet switch
- Configuration terminal (it can be PC)

System Installation

Preparations

Tools

Before installation, prepare slotted point screwdriver/cross point screwdriver, level, ruler or tapeline, and anti-static equipment.

Cabinet Installation

Check Cabinet

After MP1800 router is configured with the private brackets, it can be installed and fixed normally on 19-inch standard cabinet. Before installing MP7500, reserve enough slot room.

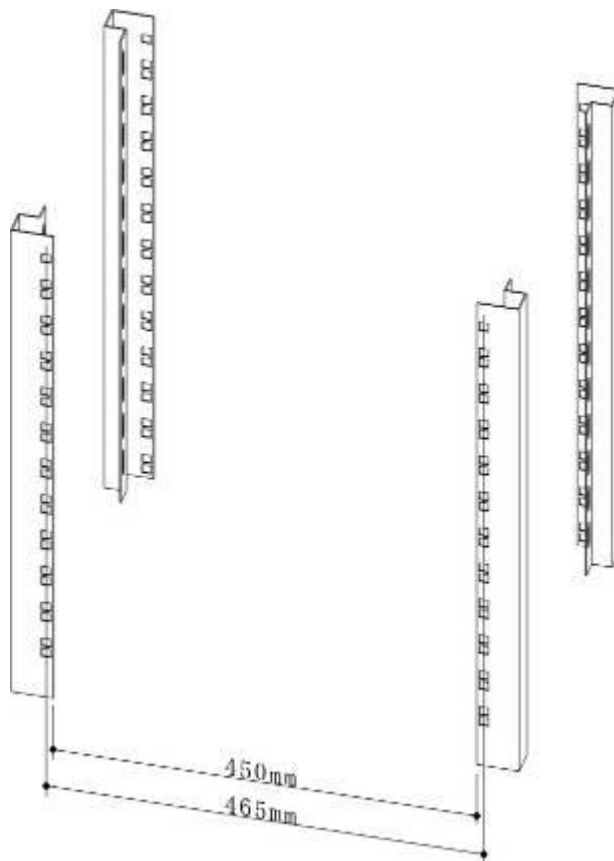

Center distance of the horizontal installation hole and net horizontal installation space

Use the level or tapeline to measure the center distance of the horizontal installation hole and net horizontal direction installation space of the cabinet.

Check whether the pallet bracket, floating nut, fixed screw, and baffle board on the cabinet are complete, which are the standard accessories. Different cabinets have different dimensions and shapes. Therefore, to add cabinet accessories, contact the supplier of the cabinet to provide genuine accessories.

The device must be installed on the pallets or trays (used in pairs) of the cabinet. Therefore, install the pallets or trays on the cabinet before installing the device as follows. Use the level to check whether the pallets or trays are horizontal. If not, adjust the fixed bolt of pallet or tray to make the pallet or tray horizontal and then fasten it.

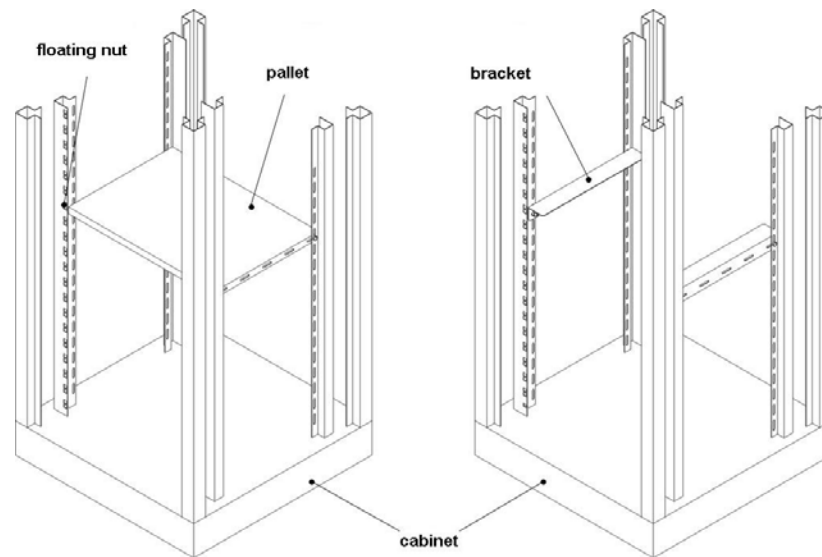

Check whether the floating nut for fixing the device is installed in the square hole of the cabinet column. If not, insert the floating nut to the square hole according to the position of the pallet or tray.

It is required that one device is placed on a pallet or a bracket. It is not recommended to overlap more than three devices.

Check Device & Accessories

After ensuring the installation environment requirements are met, open the package and check whether the router and the accessories are complete according to the purchase order.

If there is some missing or damaged items in the package, contact the equipment dealer or sales.

During check, place router and accessories at safe place to avoid falling down or impacting; keep the router far away from the places with liquids, toxic gases and dust to avoid damages on the router.

When moving or checking the device, wear gloves to avoid the corrosion of metal parts caused by perspiration.

Keep all packaging materials for later use during transporting.

Install MP1800 on Cabinet

Install MP1800 multi-service access router in the cabinet:

Step 1: Wear the gloves and anti-static wrists, and make the anti-static wrists well grounded;

Step 2: Place the device on the fixed platform; make the installation holes of the rack aim at the corresponding hole at the sides of the device; use the screws to fix the rack at the two sides of the device.

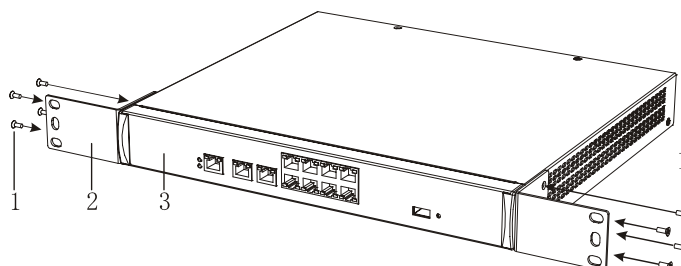

1: Screw 2: Rack 3: MP1800 host

Install device on the rack

Step 3: Make the front of the cabinet face the operator. Use two hands to hold the device stably and make the device keep horizontal. Place the device on the pallet or trays from the front of the cabinet. When placing the device, avoid the collision between the device and the cabinet column.

Step 4: Use two hands to push the device into the cabinet and make the bracket of the device close to the surface of the cabinet column.

Step 5: Use the screws to install the device on the column of the cabinet, as follows:

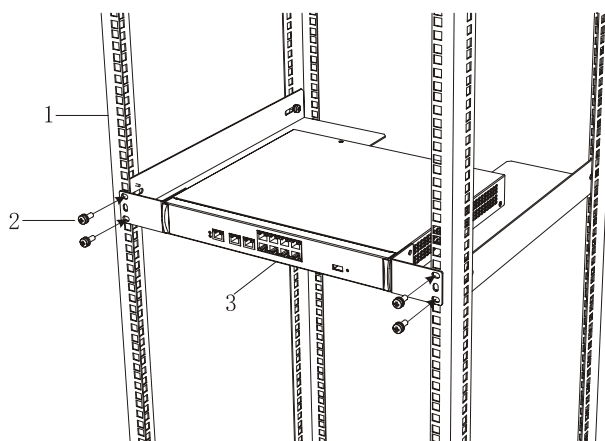

1: standard cabinet/rack 2: Screw 3: MP1800 host

Install host to cabinet

Step 6: Check whether the device is installed on the bracket fixedly and straight.

Step 7: Check whether the space between the installed devices and select the appropriate baffle to place between the devices and use the screw to fix the baffle on the shelf.

 **Caution**

Installation suggestion:

When installing multiple kinds of devices on the same cabinet, install the heavy one close to the bottom to reduce the cabinet center gravity and improve stability.

To ensure the cooling space of the device when installing the device in the cabinet, it is recommended to reserve the 1U height between the devices. Install the configured baffle of the cabinet between the devices.

Install Device on Desk

MP1800 has the features of small volume and no noise. The user can place the device on the office desk or other platform.

 **Caution**

When MP1800 is installed on the office desk or platform, there should be 50cm space reserved around the device for ventilation and cooling. Do not place sundries or other devices on the router.

Install Device on Wall

The installation steps are as follows:

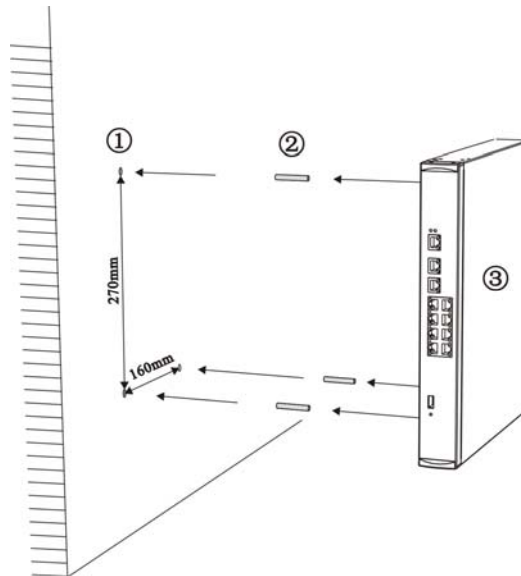

Install device on wall

Step 1: Use the impact drill to make the holes on the wall according to the dimension shown in the above figure;

Step 2: Embed the plastic expansion screw into the wall and there should be 3-4mm space between the screw end and the wall;

Step 3: Make the hang foot opening of MP1800 host aim at the expansion screw, push MP1800 slowly, and fix the device on the wall.

⚠ Caution

The depth of the hole drilled on the wall should be larger than the depth of the plastic expansion screw. The recommended external diameter of the screw is 4mm.

Connect Host Cables

This section describes how to connect the control board cable of MP1800 to the network: connecting to console port of the router.

MP1800 provides one EIA/TIA-232 asyn serial console port. With the interface, the user can adopt the character terminal with RS-232 serial port (usually, it is one common PC) to configure the router.

For the details about the connection and configuration, refer to the later chapters.

To configure the router via the terminal, connect as follows:

Step 1: Find one character terminal, which can be one standard terminal with RS-232 serial port or one common PC. Usually, it is the latter.

Step 2: When either the router or the character terminal is powered off, connect the RS-232 serial port of the character terminal to the console port of the router.

 **Note**

During connection, pay attention to the ID on the interface, avoiding inserting to other interface wrongly.

Connect Protection Ground Wire

The normal connection of MP1800 ground wire ensures protection against thunder and anti-jamming.

The AC input end of router power supply is connected to the AC noise filter, whose center is directly connected to the chassis. We call it chassis ground (that is protection ground). The chassis ground should be well grounded, so as to make the induction power and leaked power flow into the ground safely and improve the anti-electromagnetic interference feature of the device. Use one thick cable to connect the grounding point at the back of the chassis to the ground and the grounding resistance should be no more than $4\ \Omega$. If the router is installed on the 19-inch standard cabinet, the cabinet should also be grounded.

Connect Power Supply

MP1800 router adopts stable power supply switch system and has a low requirement for input AC. It supports 110V and 220V 50Hz AC. Different areas have different power supply systems.

Power Module	Input Parameter
AC power module	100V~240VAC, 50/60Hz, 1A

DC power module	-40V—-57V, 2A
-----------------	---------------

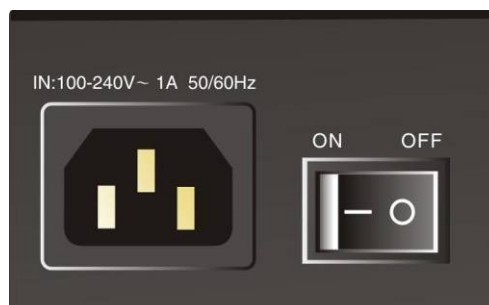

Power ports of AC device

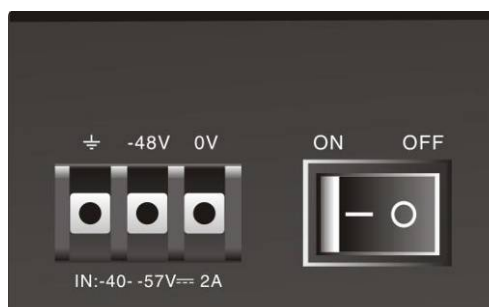

Power ports of DC device

When connecting power supply, use the below suggested power supply jack or MIM PC power supply jack for reliable grounding. When laying cables for buildings, the ground wires of the power supply system have been installed underground. Users should ensure the reliable grounding and make the corresponding processing.

The input wire of the DC power is the private three-core DC wire. Use the fork lug to connect the American standard DC terminal block (8.25 distance, M3 screw). The method of connecting the cables is as follows:

DC power cable connection relation

No.	Color	Diameter	Corresponding end
1	Blue wire	1mm ²	-48V
2	Black wire	1mm ²	0V
3	Yellow and green wire	1mm ²	Protection ground

The following is the common AC power jack:

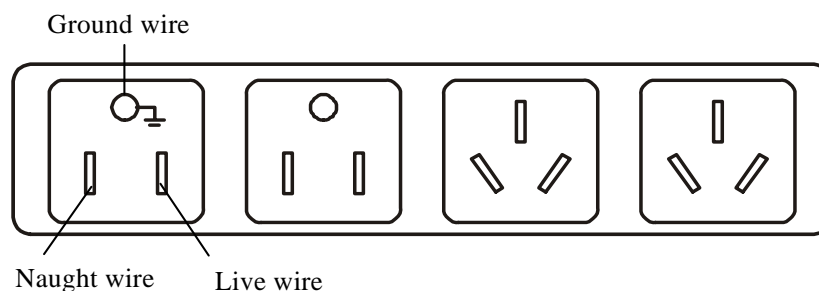

Connect the power supply as follows:

Step 1: Put the power supply switch of MP1800 to OFF. For AC router, connect one side of AC power supply cable to the AC power input end of the back panel of the router and another side to power supply jack; for DC router, connect the power cable to the post according to the description of panel silk screen on the interface.

Step 2: Put power supply switch to ON.

Step 3: Check whether the power supply indicator of the front panel is on. If not, repeat step 1 and 2.

 **Note**

If the power supply indicator is not on after repeating the above steps, contact the agent.

Module Installation

Connect 1SAE Interface Cable

This section describes the precautions of 1SAE module and cable connection.

Precautions

Before connecting syn/asyn serial port, ensure the following:

The type of the device connecting syn/asyn serial port, that is, syn/asyn, DTE/DCE; The signal standard, baud rate and sync clock required by the access device.

1. Introduction to DTE and DCE

Usually, syn/asyn serial port is connected to the external Modem or TA (terminal adapter) and serves as the dialup interface. Just select the appropriate baud rate. The syn serial port can work in DTE and DCE modes. The two devices that are directly connected should work in DTE and DCE mode respectively. The DCE device provides the syn clock and specifies the communication rate, while the DTE device accepts the syn clock and communicates according to the specified baud rate. Usually, the router serves as DTE device. Whether the type of the device connected to the router is DTE or DCE refers to the MP1800 manuals.

Typical DTE and DCE devices

Device Type	Interface Type	Typical Device
DTE	Pin type	PC Router
DCE	Hole type	MODEM Multiplexer CSU/DSU

2. Rate and transmission distance

Sync/async serial supports different signal standards and baud rate in different working modes. Choose cables according to prevailing actual conditions. The maximum transmission distance of the signals and the set BR depend on the selected cables.

V.24 cable rate and transmission distance:

BR (bps)	Max. transmission distance (m)
2400	60
4800	60
9600	30
19200	30
38400	20
64000	20
115200	10

V.35 cable rate and transmission distance:

BR (bps)	Max. transmission distance (m)
----------	--------------------------------

2400	1250
4800	625
9600	312
19200	156
38400	78
56000	60
64000	50
2048000	30

 **Note**

When adopting EIA/TIA-232 cable, BR rate should not be over 64Kbps in syn mode.

Connect 1SAE Module Interface Cable

Connect the cables of syn/asyn serial port module as follows:

Step 1: Insert one side of DB-25 to the DB-25-interface of the 1SAE module and then screw down fixed knob to fix the cable on the DB-25-interface of the 1SAE module.

Step 2: Connect another DB25 interface to V.24-V.35 (DB-25, M-34) cable and then connect to the following equipment:

1. If WAN is DDN line, connect (V.35 cable) to digital Modem V.35 interface.
2. If WAN is dialup line, connect (V.24 cable) to analog Modem serial port.

 **Note**

When connecting, pay attention to the ID on the interface, avoiding inserting into other interface and damaging the module or router host.

Connect 1CE1/1E1 Module Interface Cable

Connect 1CE1/E1 interface according to the following steps:

Step 1: Connect one side of BNC plug to the BNC interface of 1CE1/E1 module.

Step 2: Connect another side to the equipment.

TX cable should be connected with the RX cable of the peer device. The RX cable should be connected with TX cable of the peer device.

Step 3: After power on, check LOS status of 1CE1/E1 module. If indicator is on, it indicates that the circuit fails and signal loses sync, so check the line. In E1 transparent 2M mode, LOS is always on.

Connect with RJ45-RJ45 straight-through twisted-pair if you are using RJ45 interface. BNC and RJ45 cannot be used at the same time.

 **Note**

1. When connecting, pay attention to the ID on the interface, avoiding inserting into other interface and damaging the module or router host.
2. For the E1 module, the LOS is on in the transparent 2M mode; in non-transparent 2M mode, LOS is on when not finding the frame synchronous signal and then becomes off after synchronization.

Connect 1VOP/2VOP Module Interface Cable

Connect the cables of the VOP module as follows:

Step 1: Insert the telephone line to the RJ11/RJ45 interface of 1VOP/2VOP and the other side to the telephone.

Step 2: During the call, pay attention to the indicator on the back panel of the 1VOS/2VOS card. The indicator of each channel should be on during the call and the Active light of the slot on the front panel should also be on. Otherwise, contact the agent.

 **Note**

When connecting, pay attention to the ID on the interface, avoiding inserting into other interface and damaging the module or router host.

Connect 1VOS/2VOS Module Interface Cable

Connect the cable of the VOS module as follows:

Step 1: Connect the phone cable to the RJ11/RJ45 interface of 1VOS/2VOS and the other side to the small switch or external distribution box.

Step 2: During the call, pay attention to the indicator on the back panel of the 1VOS/2VOS card. The indicator of each channel should be on during the call and the Active light of the slot on the front panel should also be on. Otherwise, contact the agent.

 **Note**

When connecting, pay attention to the ID on the interface, avoiding inserting into other interface and damaging the module or router host.

Connect 1ST Module Interface Cable

Connect the cables of the 1ST module as follows:

Step 1: Insert the RJ45 plug of the 1ST module interface cable to the RJ45 jack;

Step 2: Connect the other side of the interface cable to the corresponding device wire.

Connect 8AX Module Interface Cable

Connect the cables of the 8AX module as follows:

Step 1: Connect the DB60 plug of the 8AX module interface cable to the jack of the module. Pay attention to the positive and negative directions of the connector. Tighten the knob to fix the cable on the jack of the 8AX module.

Step 2: Connect the RJ45 interface of the cable to the corresponding device.

Connect ADSL Module Interface Cable

Step 1: Connect the RJ11 plug of the ADSL module interface cable to the RJ11 jack.

Step 2: Connect the other side of the RJ11 plug to the corresponding device.

Connect G.SHDSL Module Interface Cable

Step 1: Connect the RJ45 plug of the G.SHDSL module interface cable to the RJ45 jack.

Step 2: Connect the other side of the RJ45 plug to the corresponding device.

Connect 4S1O Module Interface Cable

Step 1: Connect the RJ11 plug of the 4S1O module interface cable to the RJ11 jack.

Step 2: Connect the other side of the RJ11 plug to the telephone (To connect the FXO port, first connect the private distribution box and then connect the external line via the output FXO port of the distribution box).

Cables

Ethernet Interface Cable

Ethernet interface cable of MP1800 router adopts 8-core non-screen twisted pair. In 10BASE-T and 100BASE-TX mode, silver plate 1 and 2 are the sending ends; silver plate 3 and 6 are the sending ends. In 1000BASE-T mode, silver plate 1, 2, 3, 4, 5, 6, 7, and 8 are all used for receiving and sending signals.

The connection relation of RJ45 straight-through cable (type-5 twisted-pair):

RJ45	Signal	Direction	RJ45	Description	Length
1	TX0+	—>	1	Twisted-pair 1	2m
2	TX0-	—>	2		
3	RX0+	<—	3	Twisted-pair 2	
6	RX0-	<—	6		
4	----	----	4	Twisted-pair 3	
5	----	----	5		
7	----	----	7	Twisted-pair 4	
8	----	----	8		

The connection relation of RJ45 straight-through cable (type-5 twisted-pair): in 1000BASE-T mode

RJ45	Signal	Direction	RJ45	Description	Length
1	TRD0+	<—>	1	Twisted-pair 1	2m
2	TRD0-	<—>	2		
3	TRD1+	<—>	3	Twisted-pair 2	
6	TRD1-	<—>	6		

4	TRD2+	<—>	4	Twisted-pair 3
5	TRD2-	<—>	5	
7	TRD3+	<—>	7	Twisted-pair 4
8	TRD3-	<—>	8	

Ethernet Optical Interface Cable

The Ethernet optical interface cable of MP1800 is the single-mode or multi-mode fiber of the LC interface.

Console Port Cable

MP1800 console port cable is connected with PC 9-core serial jack, and it is 8-core non-screen cable. One side is RJ45 plug and another is DB9 (hole).

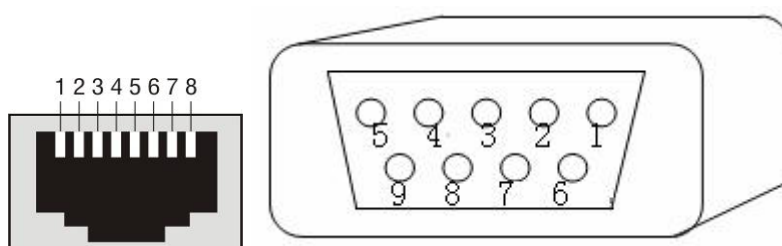

RJ45 jack

Standard DB9 interface

The connection relation of the console interface cable:

RJ45	Signal	Direction	DB9	Length
1	CTS	—>	8	3m
2	DSR	—>	6	
3	RXD	—>	2	
4	GND	---	5	
5	---	---	---	
6	TXD	<—	3	
7	DTR	<—	4	
8	RTS	<—	7	

	---	---	1	
	---	---	9	

4S1O Interface Distribution Box

Usage: Used to separate the FXO/FXS mixed signals of the 4S1O card.

Description: Three port distribution boxes, including one input RJ11 port LINE and two output RJ11 port FXS and FXO. The input end needs to connect the 4-core telephone line and the output end needs to connect the 2-core telephone line.

The sequence relation of the input and output ports:

Input Port		Cable Color	Output Port	
LINE	1	Black	1	FXO
	4	Yellow	2	
	2	Red	1	FXS
	3	Green	2	

The picture of the distribution box:



4S1O Interface Cable

Usage: Used to output the FXS/FXO mixed signals of the 4S1O card.

Description: The two ends are both RJ11 crystal head, connected to the output end of the 4S1O mixed interface and the LINE end of the distribution box respectively.

Cables: The ordinary telephone line; the cable sheath is white.

The sequence relation:

RJ-11	RJ-11	Color	Length
1	1	Black	0.5m
2	2	Red	
3	3	Green	
4	4	Yellow	

Note: The pins of the RJ11 crystal head are as shown in the following figure. The side facing the contact chip of the crystal head are pin 1, pin 2... pin 4 from right to left.



The pin order of RJ-11 crystal head

G.SHDSL Interface Cable

Usage: Used to connect the signals of the G.SHDSL card to the telephone line.

Description: One side is the RJ45 crystal head and the other side are the dispersive lines with labels. The corresponding relation is: 1-2; 3-6; 4-5; 7-8.

Cable: Twisted pair, CAT 5E, 8-core, every two are twisted; the external diameter is 6mm; the cable sheath is black green.

The sequence and label character are as follows:

RJ-45	ID Character	Color	Description	Length
1	T1	Orange and white	Twisted pair 1	3m
2	R1	Orange		
3	T2	Green and white	Twisted pair 2	
6	R2	Green	Twisted pair 3	
4	T0	Blue		
5	R0	Blue and white	Twisted pair 4	
7	T3	Brown and white		
8	R3	Brown		

Note: The pins of the RJ45 crystal head are as shown in the following figure. The side facing the contact chip of the crystal head are pin 1, pin 2... pin 8 from right to left.



The pin order of RJ-45 crystal head